

CVC Words - Beginning Sounds

Write the missing sounds.

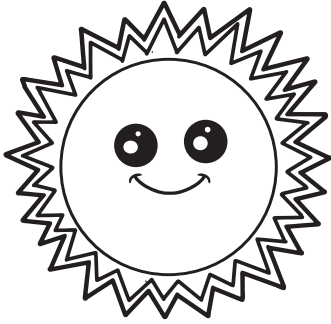

U

N

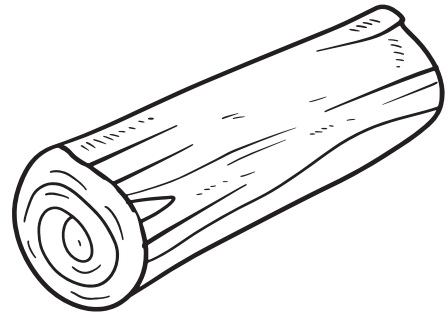

O

G

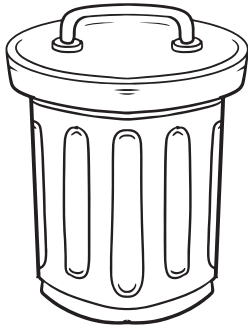

I

N



E

D

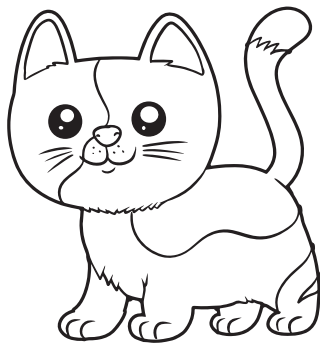

A

T

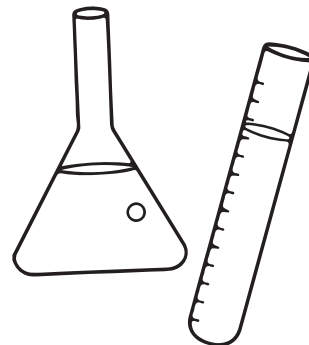

A

B

CVC Words - Beginning Sounds

Write the missing sounds.

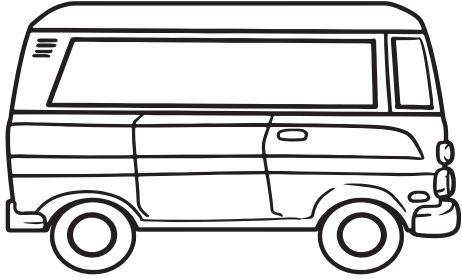

A

N

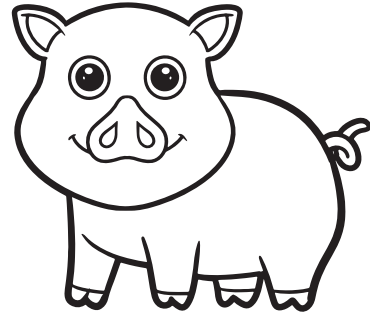

I

G

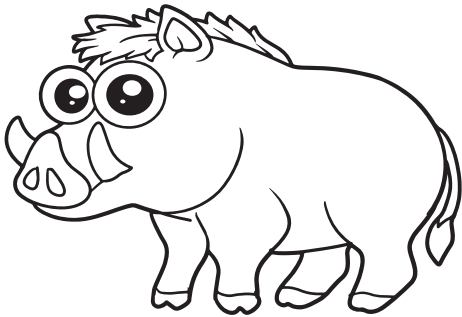

O

G

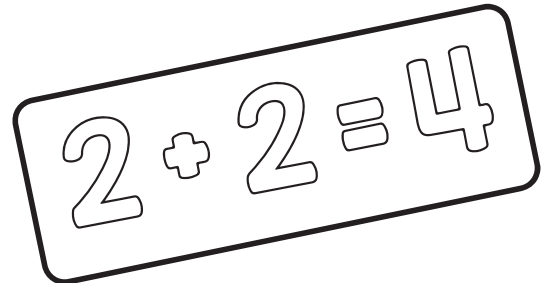

U

M

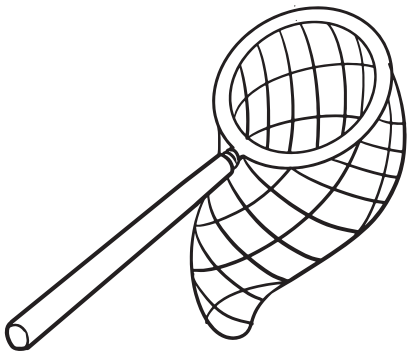

E

T

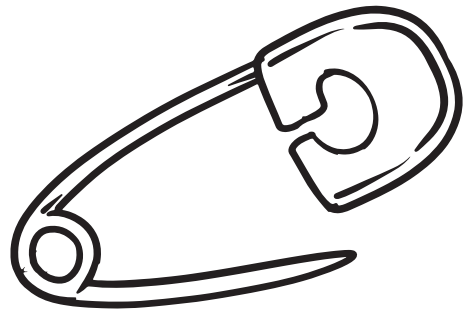

I

N

CVC Words - Beginning Sounds

Write the missing sounds.



	A	B
--	---	---

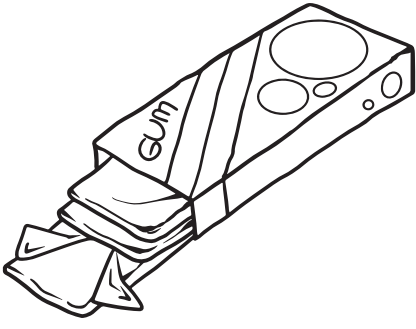

	U	M
--	---	---

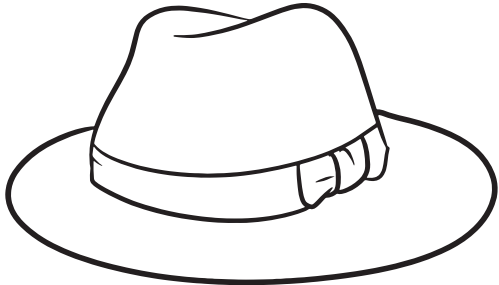

	A	T
--	---	---



	I	G
--	---	---



	O	P
--	---	---

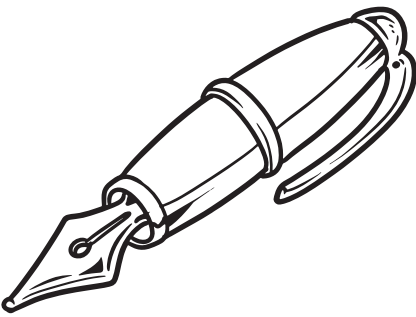

	E	N
--	---	---

CVC Words - Beginning Sounds

Write the missing sounds.

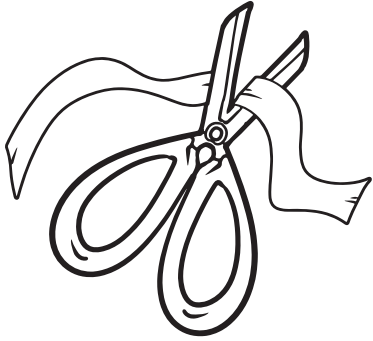

U

T

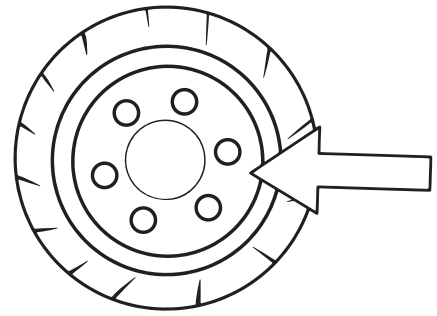

I

M

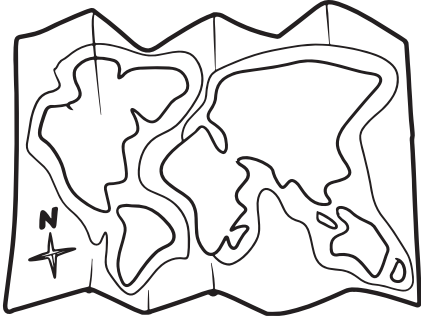

A

P

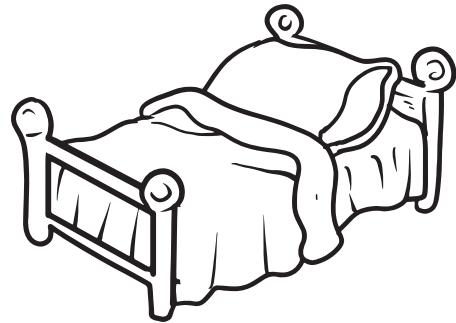

E

D



I

G



U

D

CVC Words - Beginning Sounds

Write the missing sounds.

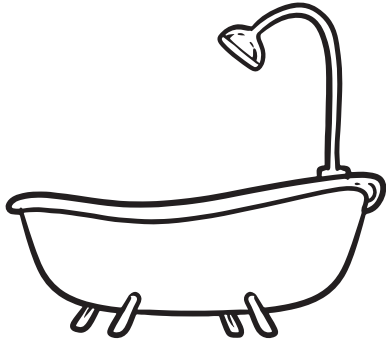

U

B

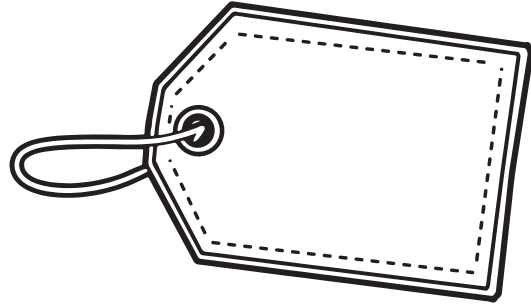

A

G

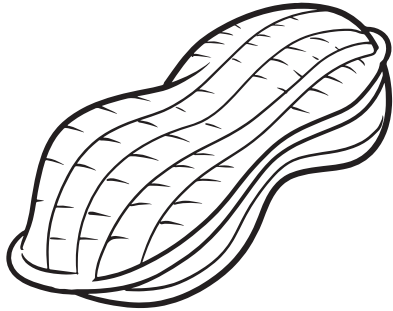

U

T

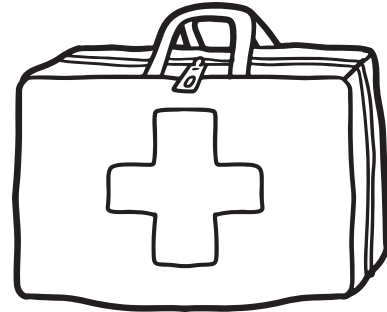

I

T

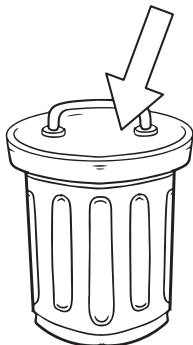

I

D



O

B

CVC Words - Beginning Sounds

Write the missing sounds.

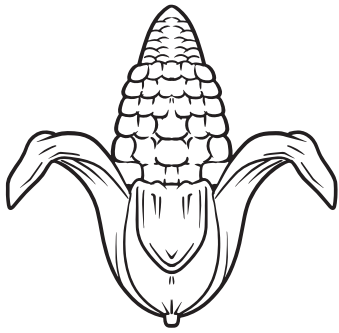

O

B

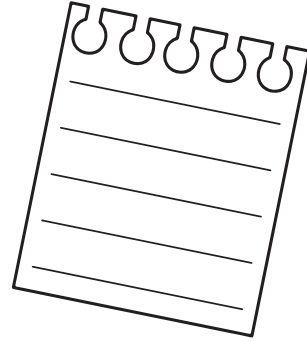

A

D

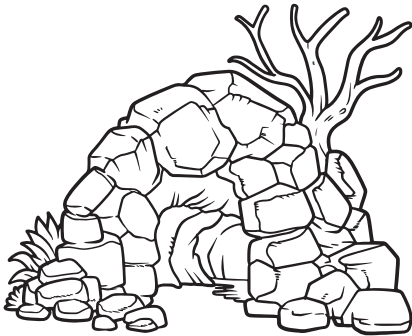

E

N

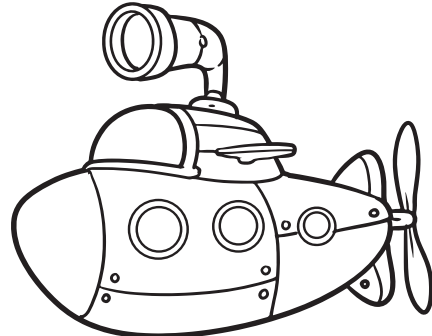

U

B



A

M

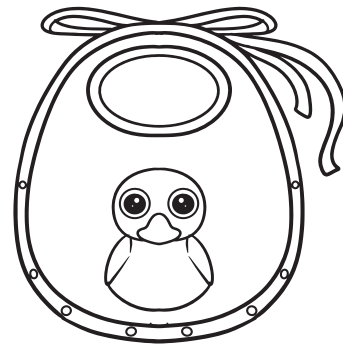

I

B

CVC Words - Beginning Sounds

Write the missing sounds.

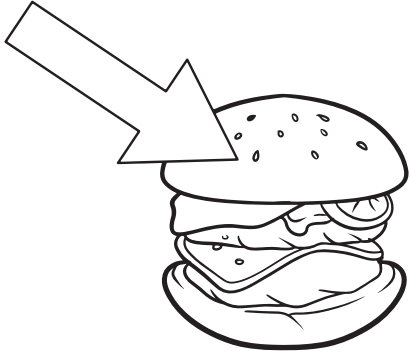

	U	N
--	---	---

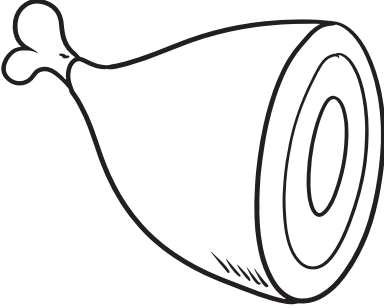

	A	M
--	---	---

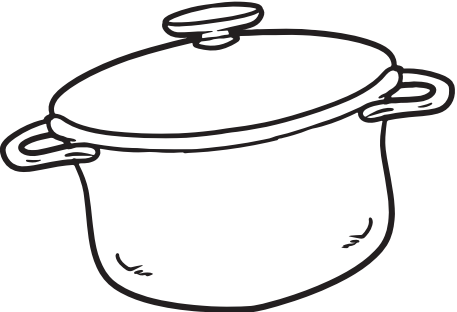

	O	T
--	---	---



	E	T
--	---	---

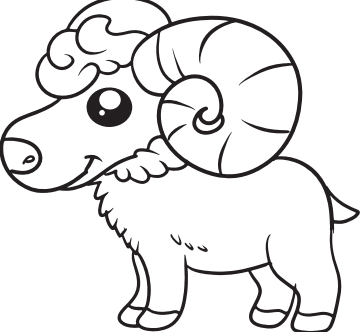

	A	M
--	---	---

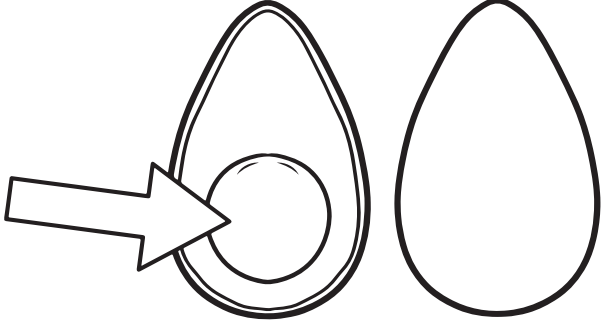

	I	T
--	---	---

CVC Words - Beginning Sounds

Write the missing sounds.



U

G

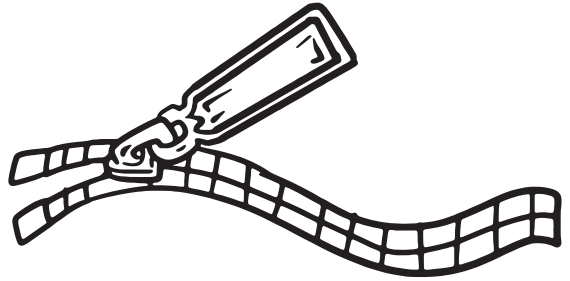

I

P

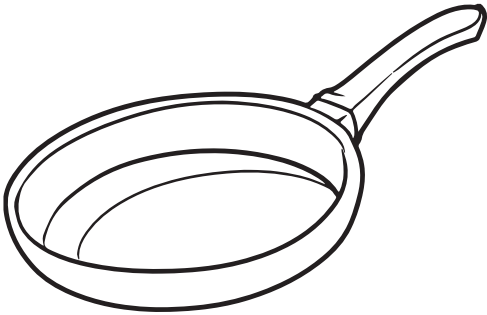

A

N

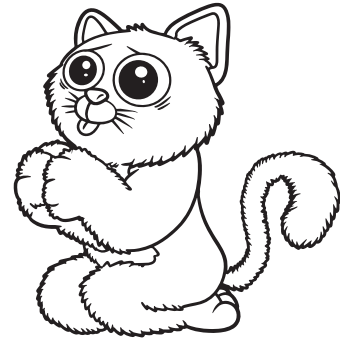

E

G

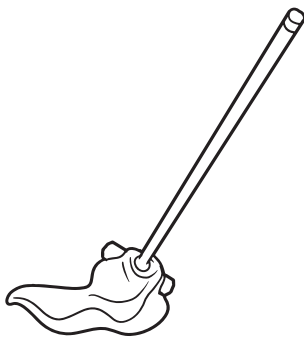

O

P





A

D

CVC Words - Beginning Sounds

Write the missing sounds.

		
	I	D

		
	U	G

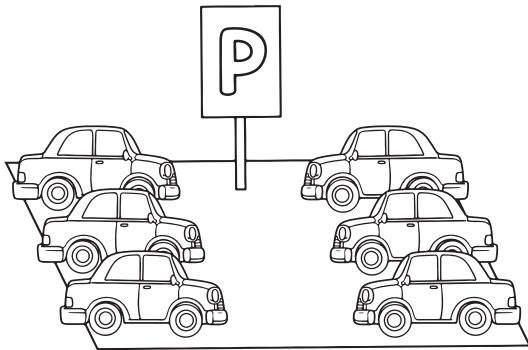
		
	O	T

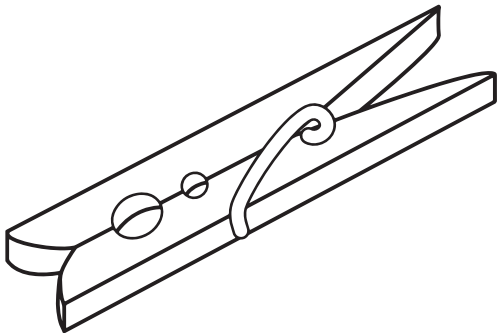
		
	E	G

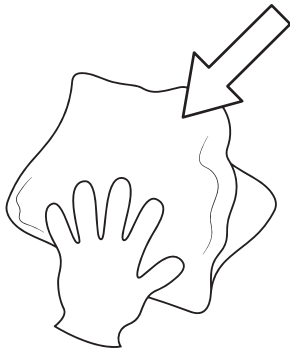
		
	A	G

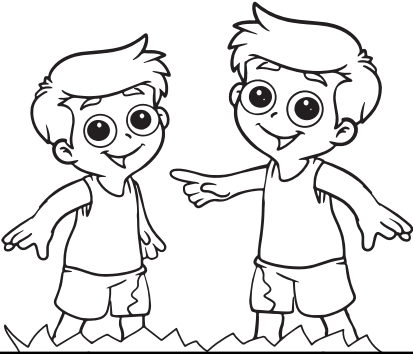
		
	I	M

CVC Words - Beginning Sounds

Write the missing sounds.



U

D

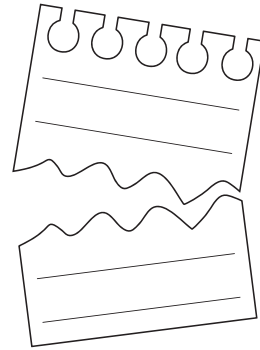

I

P

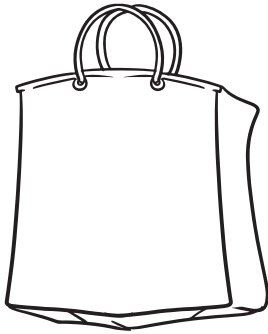

A

G

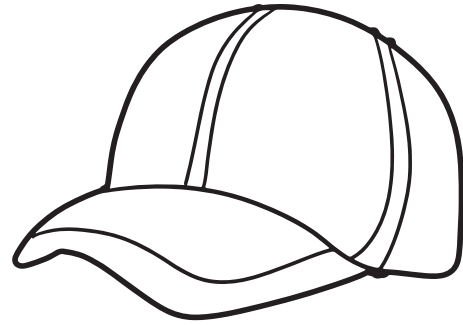

A

P

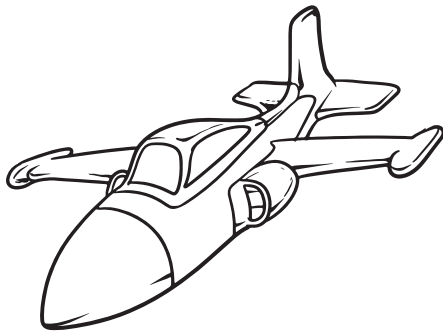

E

T



I

N