

Name: _____

Color all the words
that rhyme with **lab**.

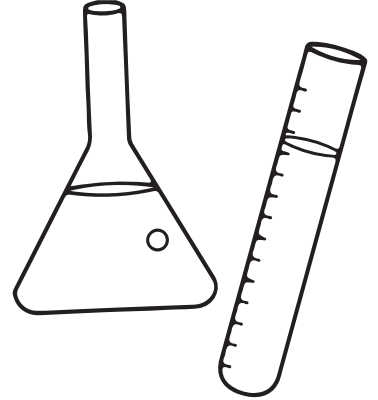

tab

nab

win

mud

cab

pen

dab

hat

lab

dad

cob

Name: _____

Color all the words
that rhyme with **dad**.



bad

sob

pad

sad

cut

lad

cat

gum

fan

mad

fog

Name: _____

Color all the words
that rhyme with **bag**.



hag

pat

rag

him

fit

nag

tag

cab

gag

rob

wag

Name: _____

Color all the words
that rhyme with **ram**.



fig

ham

dam

yam

tap

sat

hut

jam

Sam

bag

log

Name: _____

Color all the words
that rhyme with **pan**.



can

tag

ran

van

man

rut

sun

rid

dip

fan

cop

Name: _____

Color all the words
that rhyme with **map**.

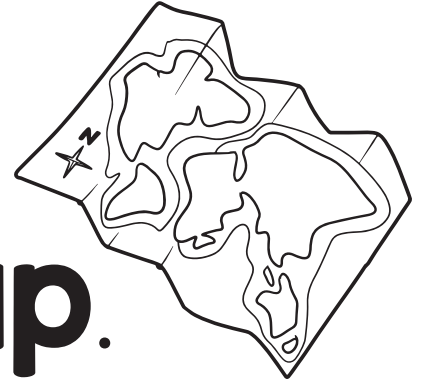

gig

cap

rim

sad

fat

nap

gap

bun

lap

pet

tap

Name: _____

Color all the words
that rhyme with **cat**.

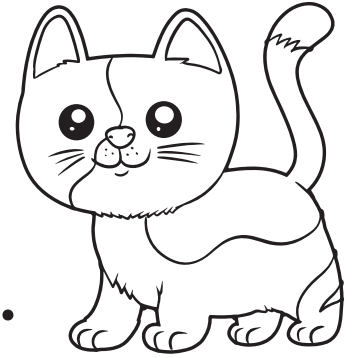

dog

sad

hat

pit

bat

sum

lit

sat

mat

pot

rat

Name: _____

Color all the words
that rhyme with **bed**.

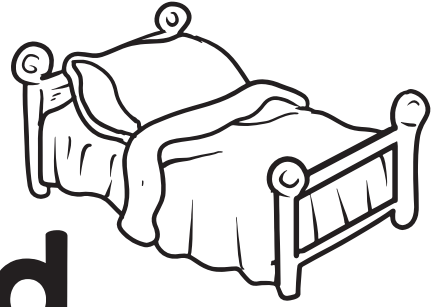

cob

bid

wed

fed

jam

led

hag

kid

Ted

vet

red

Name: _____

Color all the words
that rhyme with **peg**.



beg

leg

yam

dog

had

fun

keg

fog

hut

lip

Meg

Name: _____

Color all the words
that rhyme with **pen**.

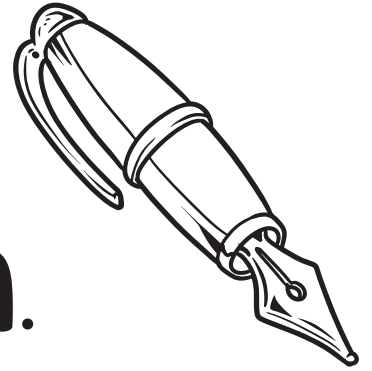

mat

set

nag

den

pop

ten

hen

kit

lab

wed

men

Name: _____

Color all the words
that rhyme with **net**.

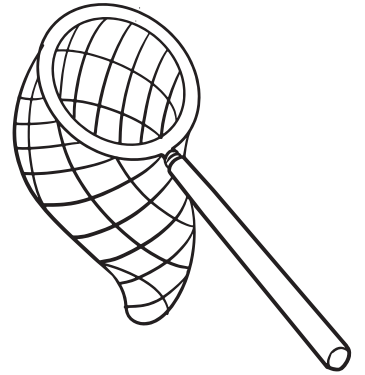

bet

jet

dig

mud

pet

mad

pan

wet

vet

net

zip

Name: _____

Color all the words
that rhyme with **bib**.

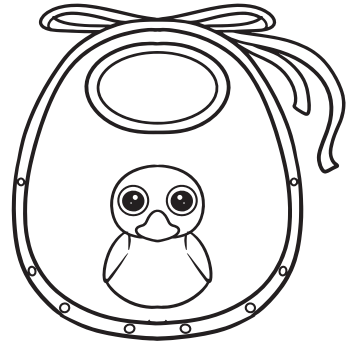

cot

mop

fib

tab

nib

pig

fit

wig

jib

men

rib

Name: _____

Color all the words
that rhyme with **kid**.



fid

dip

bid

pet

lid

did

sin

rid

hid

nut

cup

Name: _____

Color all the words
that rhyme with **pig**.

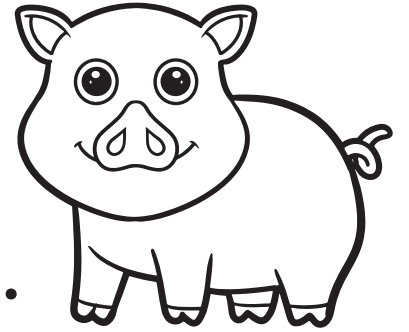

sip

cap

big

wig

nag

fig

fan

dig

set

gig

rim

Name: _____

Color all the words
that rhyme with **rim**.

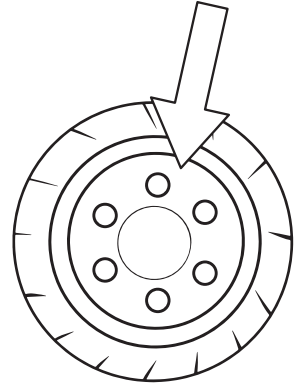

bog

top

den

dim

hat

him

pop

Tim

Kim

gag

but

Name: _____

Color all the words
that rhyme with **bin**.

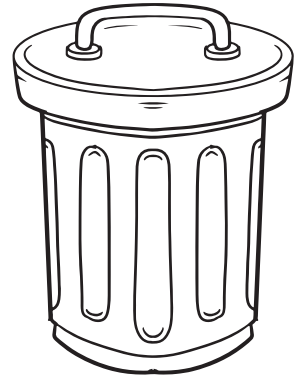

ten

fin

rag

lot

pin

dad

gun

sub

win

rat

tin

Name: _____

Color all the words
that rhyme with **zip**.

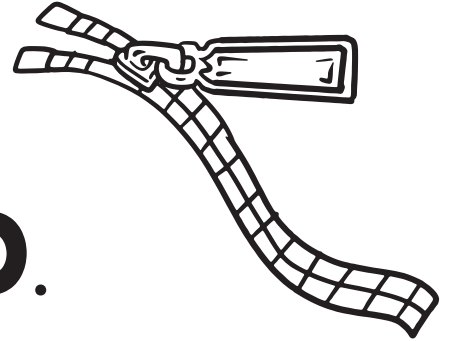

hip

beg

lip

ban

top

rip

sip

dud

tip

sun

dip

Name: _____

Color all the words
that rhyme with **kit**.

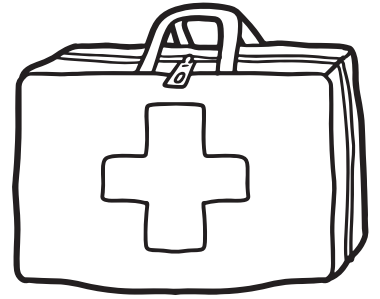

bet

lit

sit

fit

map

hit

pat

nut

run

pit

wit

Name: _____

Color all the words
that rhyme with **rob**.



cob

man

job

pad

sob

cab

keg

gob

fog

mob

gut

Name: _____

Color all the words
that rhyme with **dog**.

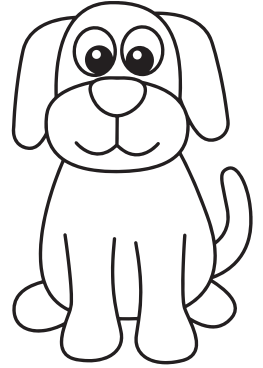

mat

sum

fog

lid

bog

log

jog

hen

pug

dot

hog

Name: _____

Color all the words
that rhyme with **mop**.



cap

hag

cop

pop

mad

top

hop

wig

fin

rut

tip

Name: _____

Color all the words
that rhyme with **hot**.



lot

mud

pot

tot

bed

log

bug

dot

pet

cot

rib

Name: _____

Color all the words
that rhyme with **sub**.

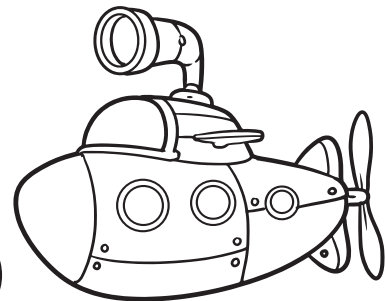

dub

can

cub

dog

tin

rub

tub

nut

hub

bin

mat

Name: _____

Color all the words
that rhyme with **bud**.



lab

mud

fog

pud

pop

fat

bad

dud

sat

cud

red

Name: _____

Color all the words
that rhyme with **rug**.

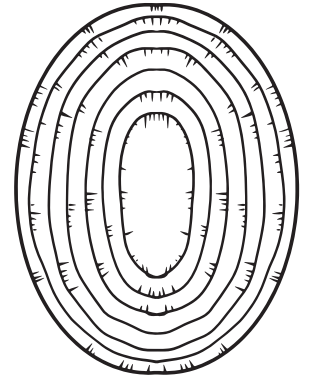

sum

keg

mug

cat

hug

him

bug

dam

tug

pug

leg

Name: _____

Color all the words
that rhyme with **gum**.



get

ten

mum

hut

yum

vet

hum

sat

hip

sum

pig

Name: _____

Color all the words
that rhyme with **sun**.

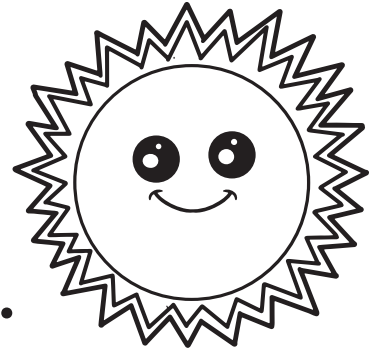

fun

gun

bun

run

hit

ran

pun

top

rat

wag

nun

Name: _____

Color all the words
that rhyme with **cut**.

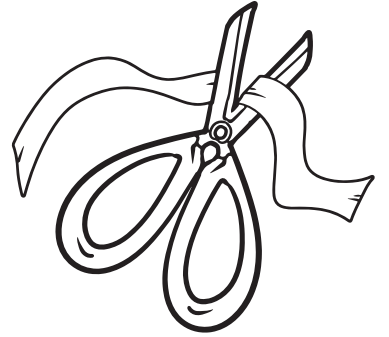

pan

sun

rut

beg

lip

jam

gut

hut

nut

pug

cab